

Powerful Electronics, Effortless Control

NAVnet  
touchXL

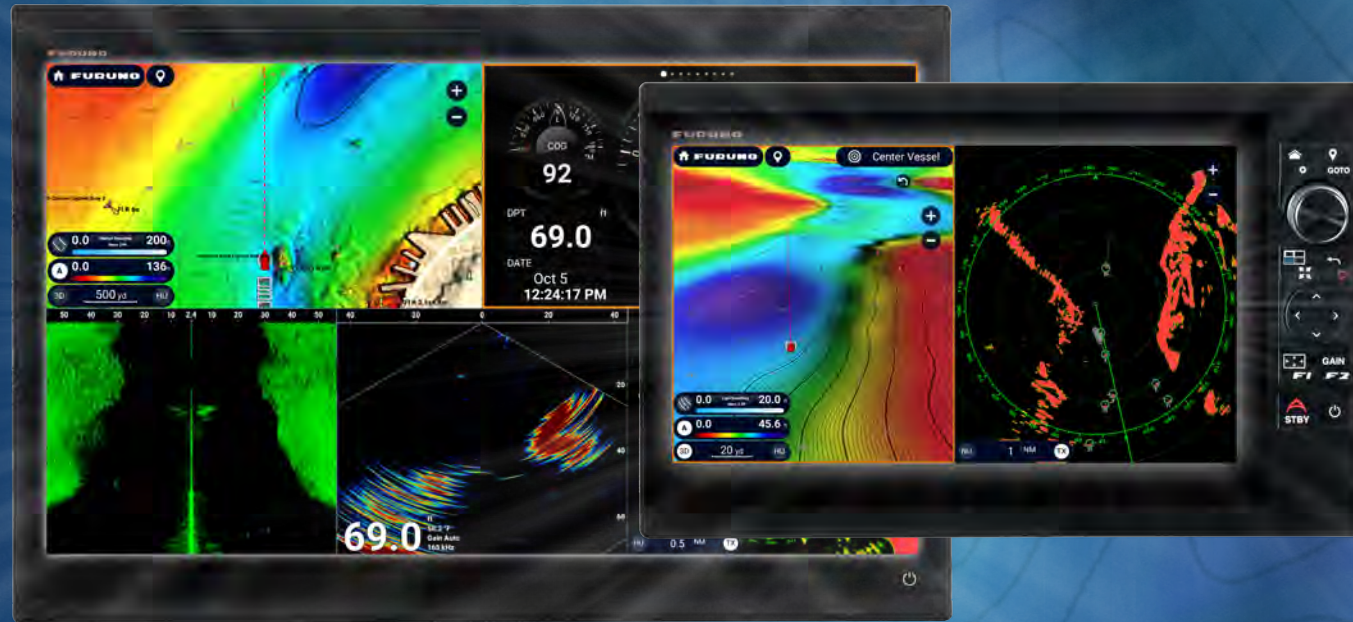

FURUNO

# NAVnet

TZ  
touchXL



## DISCOVER LIFE

Your time on the water is invaluable. It's cherished memories in the company of family and friends that will last a lifetime. It's making the most of every day, a blend of relaxation and adventure as you explore hidden treasures along the coast or seek out the next, best hotspot to cast your lines. We get it, and we're answering the call from boaters around the globe who've asked for a suite of electronics that is both powerful and easy to use, with cutting-edge features of tomorrow blended with the reliability and experience of a company with a worldwide reputation for excellence.



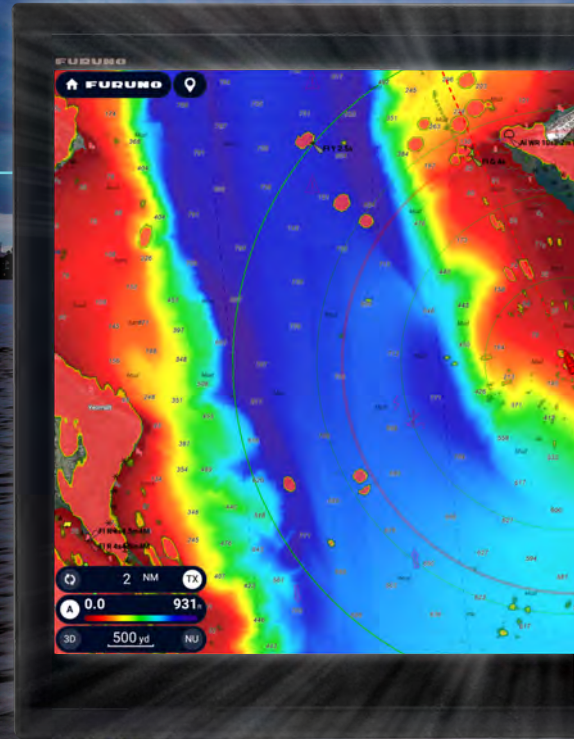

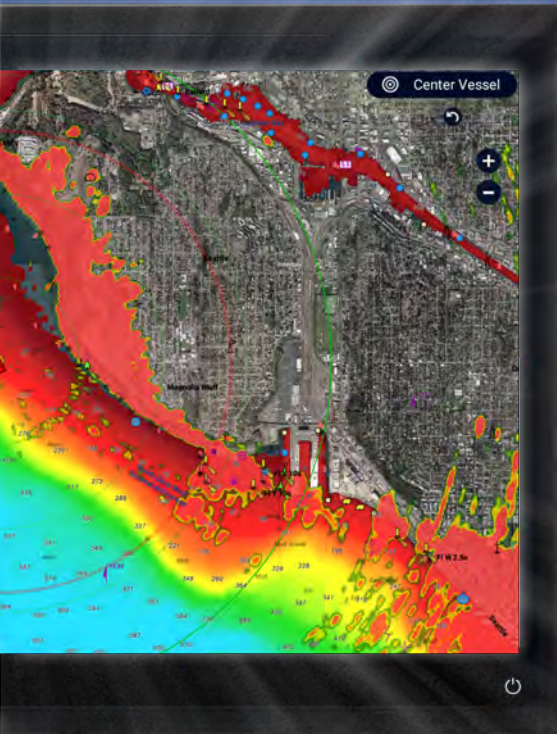

TZT24X

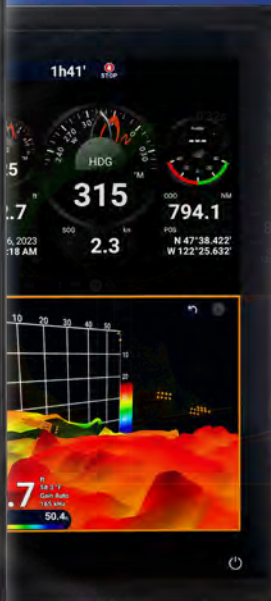

TZT22X

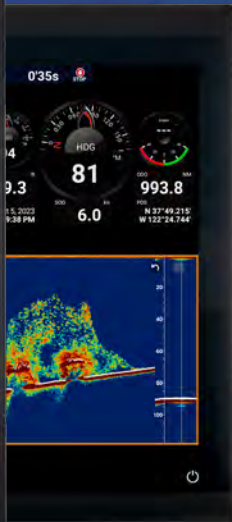

TZT16X



TZT13X



TZT10X

## Explore More

Explore the future of navigation with NavNet TZtouchXL Multi Function Displays. Extra-large, wide 16", 22", and 24" all-glass MFDs with exceptional clarity from all angles that enhance the functionality and style of your helm. Or go with the hybrid controls of the 10" & 13" options that make navigating intuitive and easy under any sea conditions, no matter the size of your vessel.

- Lightning-fast 16", 22", & 24" all-glass, or 10" & 13" Hybrid Control displays
- New TZ MAPS for highly-detailed navigation and fishing charts
- Purchase and update charts directly from MFD with internet connection
- Power-packed 100W & 200W NXT Solid-State Doppler Radars (DRS12ANXT and DRS25ANXT)
- 24" and 19" Solid-State Doppler Radome Antenna options (DRS4DNXT and DRS2DNXT)
- Built-in Dual Channel 1kW TruEcho CHIRP™ & CW Fish Finder (TZT10X/13X/16X only)
- Built-in 230kHz or 455kHz CHIRP Side-Scan (TZT10X/13X/16X only)
- Powerful hexacore processor for rapid response
- Deepwater DFF3D Multibeam Sonar for up to 300m depth & 200m Side-Scan, with Personal Bathymetric Generator (PBG)
- Video Converter Kits stream compatible Sonar video data directly to TZtouchXL MFDs
- Furuno's exclusive Fish-It, Drift-It, & Follow-It features save time and fuel, and increase fish catch
- High-power 2/3/5kW\* TruEcho CHIRP™ DFF3-UHD
- \* Built-in power is 3kW; Connect a 5kW or 10kW transducer when using the BT-5 Booster Box



# TZ MAPS An All-New Chart Engine Providing Game-Changing Safety Technology

- Affordable, highly-detailed charts purchased directly from MFD
- 1-year subscription with free updates
- Community Edit & POI
- High-resolution satellite photos
- 8 types of chart presentations
- Use your TZ MAPS across multiple MFDs, TimeZero software, or TZ iBoat app

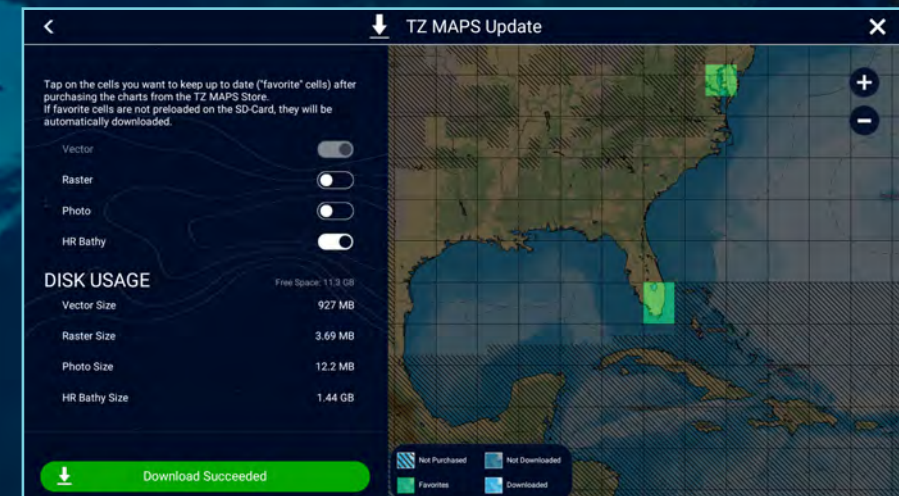
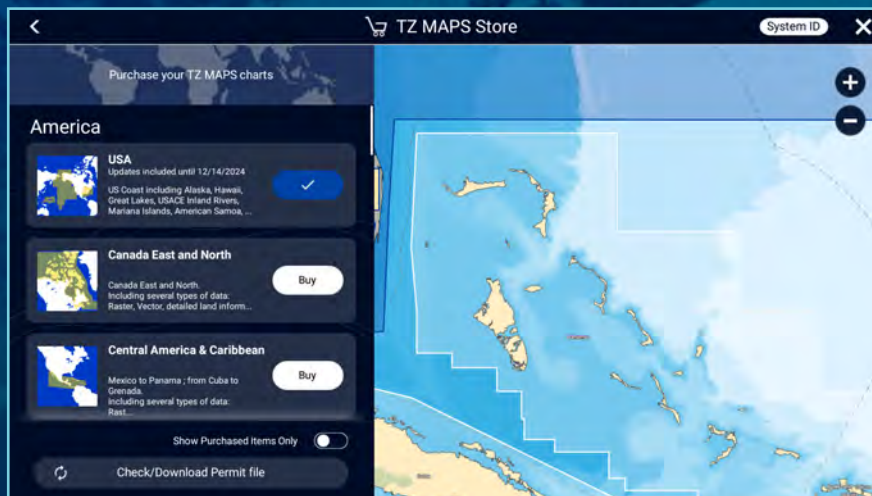

Easily purchase & unlock new chart areas directly from the MFD, then keep them up to date with just an internet connection.

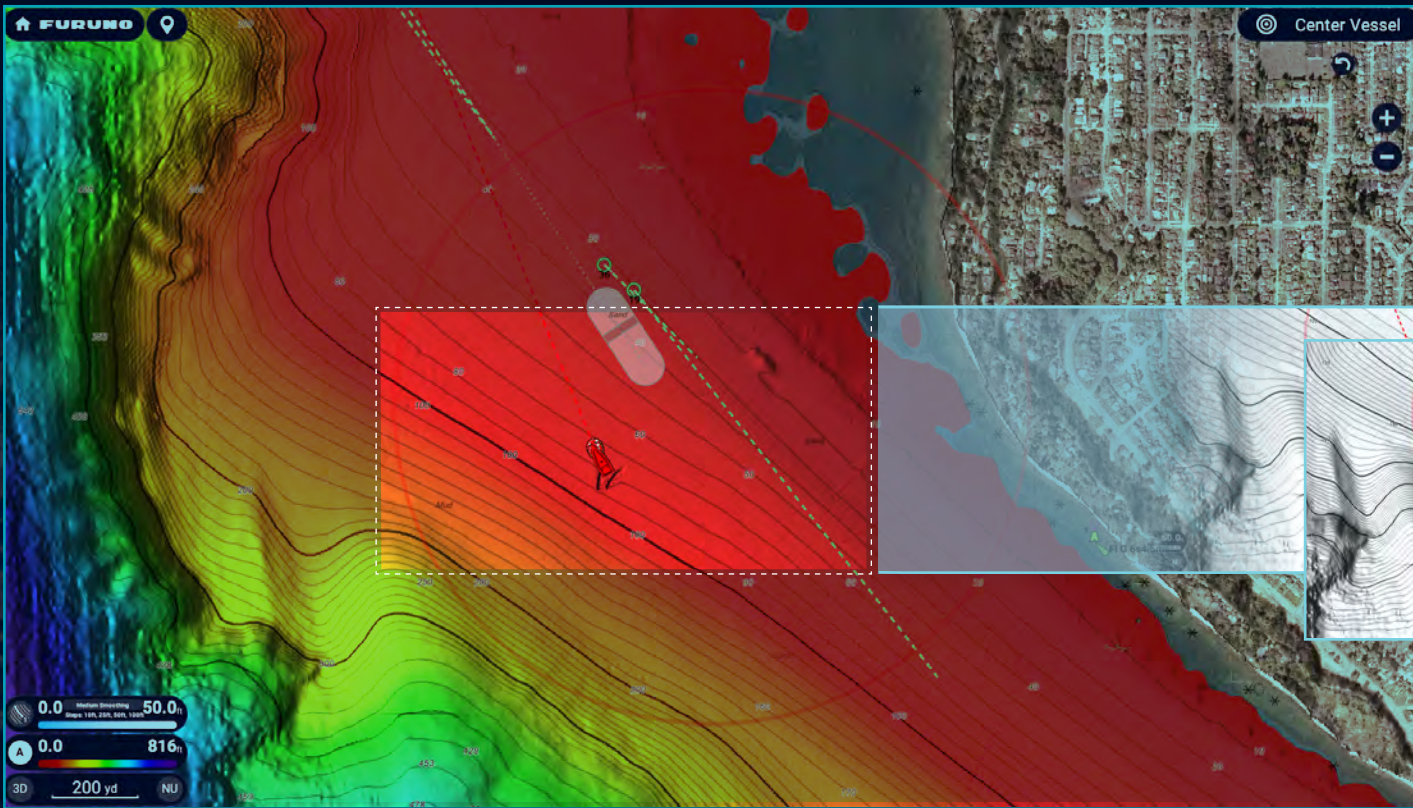

Step 1

Step 2

Step 3

Step 4

Step 5

## BATHYVISION... Reveal The Secrets Of The Seabed Like Never Before

The seabed holds many secrets! However, thanks to the advanced functionality and highly detailed information provided by our all-new BathyVision, those secrets will be revealed!

TZ MAPS offer the best bottom data available and BathyVision lets you display dynamic & intuitive high-resolution relief shading in color and/or with contour lines. Configure the density of contour lines to about 7.5 cm (3 in) & associated shading to focus precisely on high-potential fishing areas.

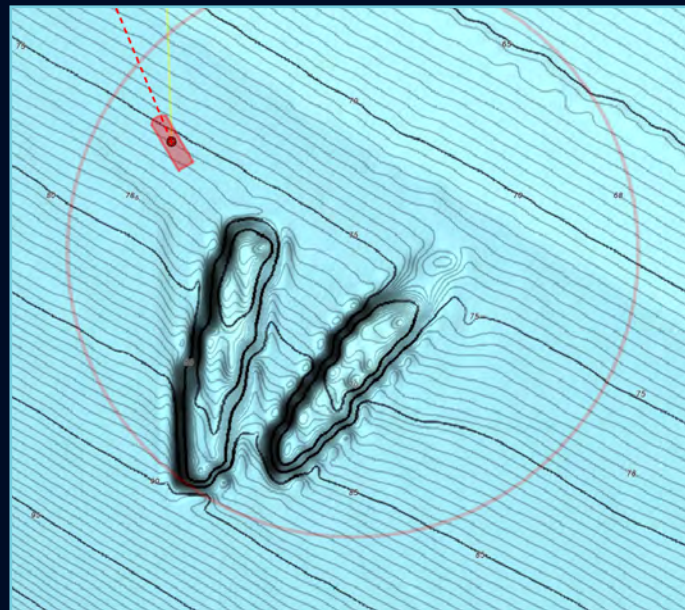

## DYNAMIC FISHING MAPS

- Choose the density of contour lines with 1 tap
- 5 levels of contours down to within 7.5 cm (3 in)
- Add dynamic color shading based on custom settings
- Adjust terrain shading for totally customized high-resolution depth contours
- Combined depth shading plus fishing charts

# AI ROUTING

Furuno's AI Routing utilizes TZ MAPS to give you a recommended point-to-point route to follow. It intelligently plans a path that takes you through channels, marina entrances, inlets, and more using your set boat draft, chart data, and other safety parameters. Once AI Route is generated, you can easily edit and add new points as desired.



The screenshot shows the Furuno AI Routing software interface. At the top, there's a header with the Furuno logo, a location pin icon, a 'Restart' button, and various navigation metrics: DTW (106 yd), BTW (277.3 'M), TTG (3'08s), TTA, and 1h34'. Below this is a 'DATA' panel with fields for DATE (9:36:07 AM), HDG (276 'M), COG (269 'M), SOG (1.0 kn), DPT (29 ft), and POS (N 25°45.886', W 80°08.072'). There's an 'EDIT' button below the data. The main part of the interface is a map showing a route through a harbor area, with various navigational aids and labels like 'Fisher Island Marina', 'Miami Main Channel', and 'Miami South Marina'. At the bottom left, there are three control buttons: '0.0' (with a 'Share SR' label), 'A 0.0' (with a '51.7 n' label), and '3D' (with a '200 yd' label). At the bottom right, there are two buttons: 'Manual' and 'AI Routing'. A black arrow points to the 'AI Routing' button, and a blue line connects it to the text 'Select Manual or AI Routing to create routes'.

Select Manual or AI Routing to create routes





- New AI algorithm analyzes nautical chart elements: water depths, channels, and recommended routes to ensure seamless & secure navigation
- Swift & precise solution for planning your next voyage
- Calculate an optimal route in seconds

STOP Center Vessel

Lat N 47°36.993'  
Lon W 122°27.774'

Range 2.042 NM  
Bearing 255.6 ° R

Depth 716 ft

Chart Object Info

New Point

Goto

Fish-It

New Route

New Boundary >

ANALYZES:  
Channels  
Water depths  
Recommended routes

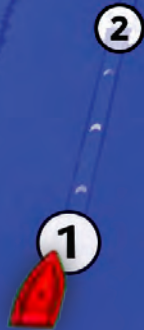

# RISK VISUALIZER

Risk Visualizer™ is a unique feature that shows potential collision areas based on the current position and movement of all surrounding vessels, providing a quick and intuitive overview of the situation around your boat.



- The new Risk Visualizer™ allows the navigator to see areas with a high risk of collision, as well as displaying the time to reach those areas
- Quick and intuitive read on potentially dangerous targets
- Color-coded alerts for collision  
Red = Hazardous / Green = Normal

\* Requires DRS Radar Sensor with latest software update

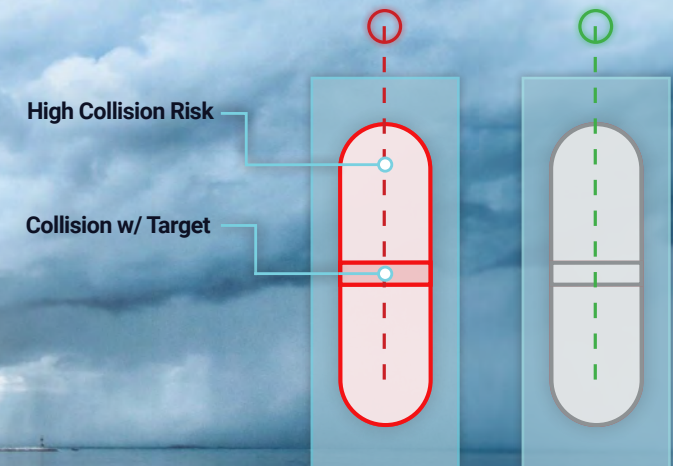

# AI AVOIDANCE ROUTE

When Risk Visualizer™ warns you of a potential collision, the new AI Avoidance Route™ calculates and plans your next move. It intelligently draws a suggested collision avoidance route that you can steer to avoid the collision, keeping you and your vessel safe.

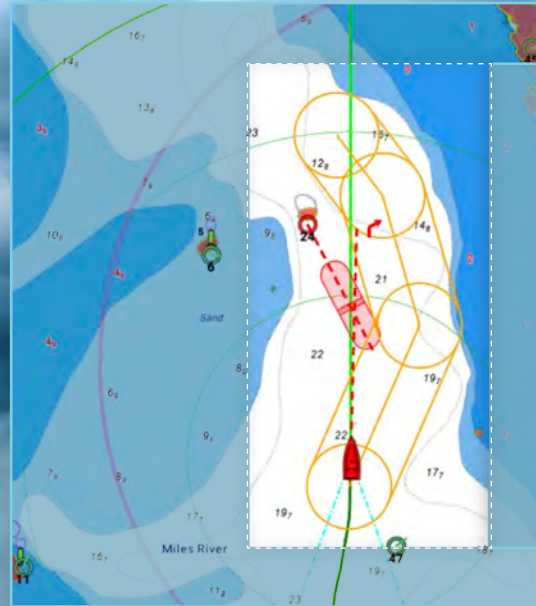
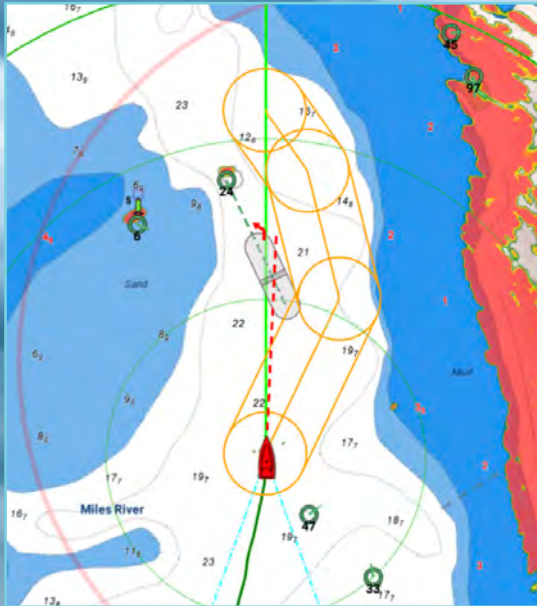

Recommended AI Avoidance Route to avoid a collision



- Uses a proprietary AI Routing algorithm to automatically calculate the best route for safety\*
- \* Requires DRS-NXT Radar Sensor with latest software update

# Total Control Made Super Simple



## INTUITIVE USER INTERFACE

You asked for the simplest interface possible, and we were listening. We've delivered the most intuitive User Interface available, bar-none. If you swipe your phone, you can operate TZtouchXL.

With edge swipe features and single-tap menu options, you're never more than a tap or swipe away from what you want to see or do, because NavNet TZouchXL provides the easiest and most powerful MFD on the planet.

Designed for captains who have multiple TZtouchXL all-glass MFDs on their helm, a single MCU006 or MCU006H can control all of the displays. It features a large RotoKey™, which can be used to zoom in/out, increase/decrease gain, and scroll through menu options. With the same 10 dedicated buttons as seen on the TZT10X/13X, you will be able to fully control all of your MFDs remotely.

MCU006



MCU006H



Top Edge Swipe - Quick Page

Left Edge Swipe - NavData

DATA	ROUTE
105	HDG °M
118	COG °M
6.0	SOG kn
DRS6A-NXT	
Gain 0	M A
Sea 0	M A
Rain 0	M A
NAVpilot	
S	TBY
105	°M
HDG	
AUTO	NAV
⌂ ⚙	
Edit	

Right Edge Swipe - Shortcuts

- Track Recording
- PBG Recording
- Star Nav
- Position Entry
- Distance
- Tide
- Smart Search
- ARPA
- NavData
- Layers
- Fuel

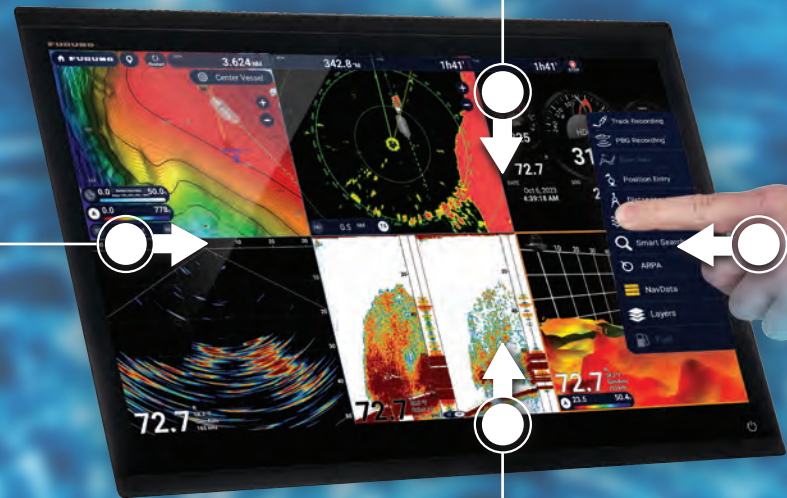

Bottom Edge Swipe - Layers

Charts	Overlays	User Objects	
Chart			3D Data Source
TZ MAPS		MM3D	+Rc Bathy
TZ Vector	TZ Raster	TZ BathyVision	Depth Shading
Additional Chart	OFF	Block Chart	Terrain Shading
			Terrain Shading Intensity (67%)
			Depth Contour
			Display Spot Soundings
			Follow-It
			Community Maps



	DOME	OPEN ARRAYS - 3.5', 4', OR 6'		
NXT	DRS2DNXT/DRS4DNXT	DRS6ANXT	DRS12ANXT	DRS25ANXT
X-CLASS	DRS4DL+/DRS4D	DRS6AX	DRS12AX	DRS25AX

## The Undisputed Benchmark For Marine Radar

However you spend your time on the water, you need a Radar you can rely on to keep you safe. Whether you choose the time-tested X-Class magnetron option or NXT Solid-State Doppler models, Furuno Radar delivers power and clarity like you've never seen and provides the assurance that you're navigating with the most reliable and feature-packed equipment on the planet. From the compact DRS2DNXT/DRS4DNXT domes to the high-power 200-watt DRS25ANXT open array, you'll quickly become accustomed to the dynamic features that only Furuno provides,

like Target Analyzer™ that lets you know of potentially hazardous targets, Fast Target Tracking that displays a speed and course vector in seconds, best-in-the-business Bird Mode to track elusive flocks and even individual birds feeding on baitfish, and Rain Mode that can pick out and display in different colors the targets you need to see through even the nastiest of squalls. (Some features may require additional sensors)

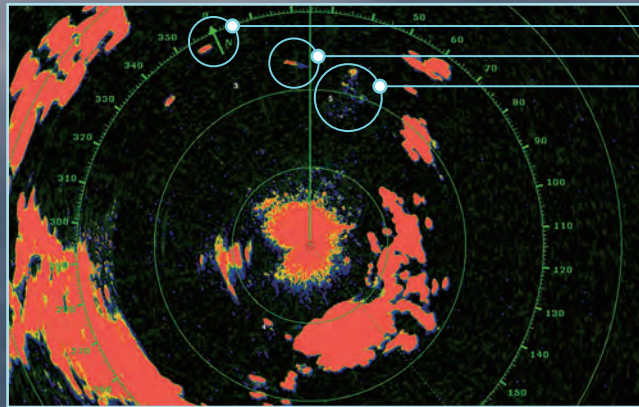
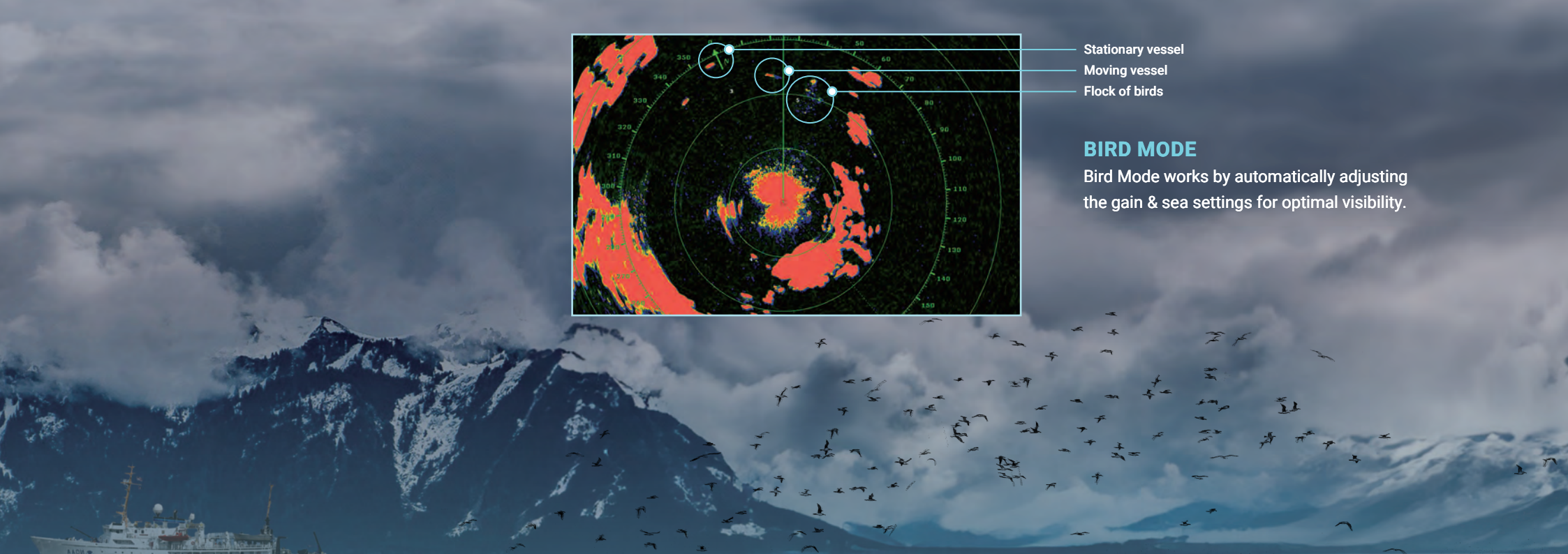

- Stationary vessel
- Moving vessel
- Flock of birds

### BIRD MODE

Bird Mode works by automatically adjusting the gain & sea settings for optimal visibility.

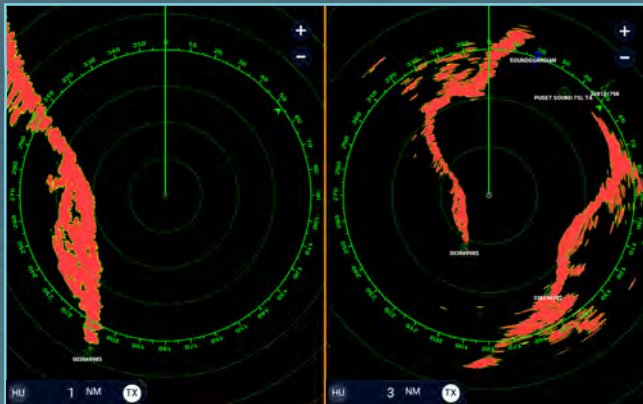

### DUAL RANGE MODE

Display two independent Radar screens with independent control over gain and anti-clutter

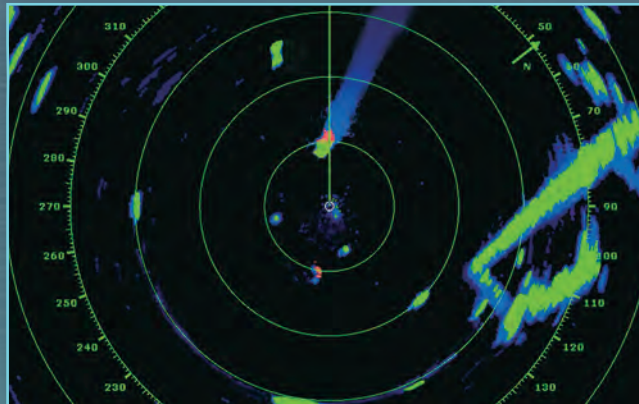

### TARGET ANALYZER™

To warn of potential hazards approaching

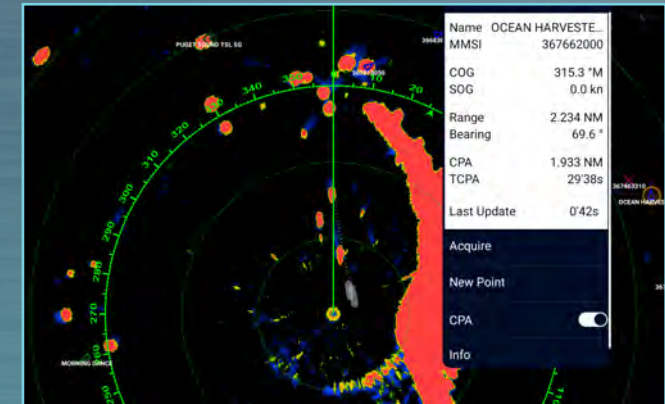

### AIS TARGET TRACKING

Display AIS targets on your Radar and Chart Plotter

# Your Ultimate Fishing Dream Machine

TZtouchXL incorporates a powerful internal 1kW dual channel TruEcho CHIRP™ Fish Finder\* designed to operate across a wide range of frequencies. For those who want to go even deeper, the 2kW/3kW DFF3-UHD TruEcho CHIRP™ Network Fish Finder delivers the ability to penetrate the deepest waters to find your catch. And with the BT-5 Booster Box, you can boost that output power up to 5 or 10kW to take advantage of high-power transducer options that will unveil the deepest waters like you've never experienced before.

\* Note: Built-in Fish Finder available in TZT10X/13X/16X only



**DFF3-UHD High-Power TruEcho  
CHIRP™ Network Fish Finder**



## BUILT-IN CHIRP SIDE-SCAN

Furuno's CHIRP Side-Scan for NavNet TZtouchXL scans both port and starboard, illuminating the shape of bottom structure in high definition. CHIRP Side-Scan reveals the shape of fish targets and fish-hoarding structure to each side of your vessel. CHIRP from 230kHz or 445kHz center frequencies with thru-hull, paired, or transom mount transducer options. (TZT10X/13X/16X only)

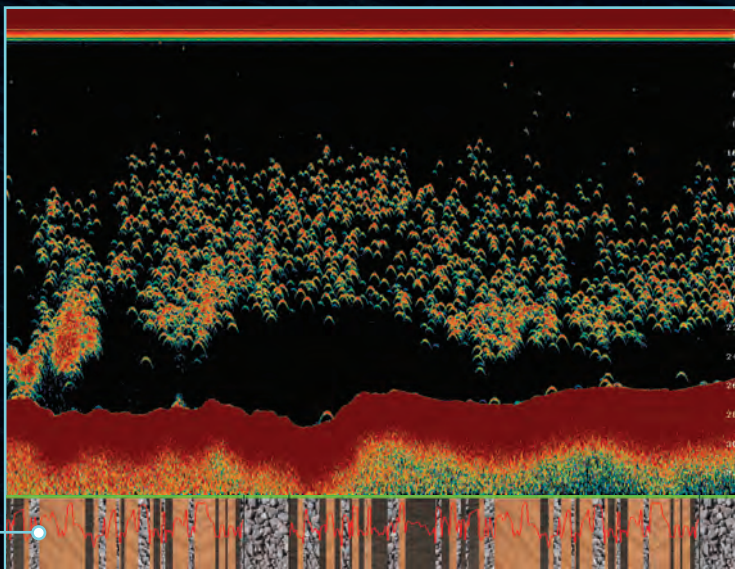
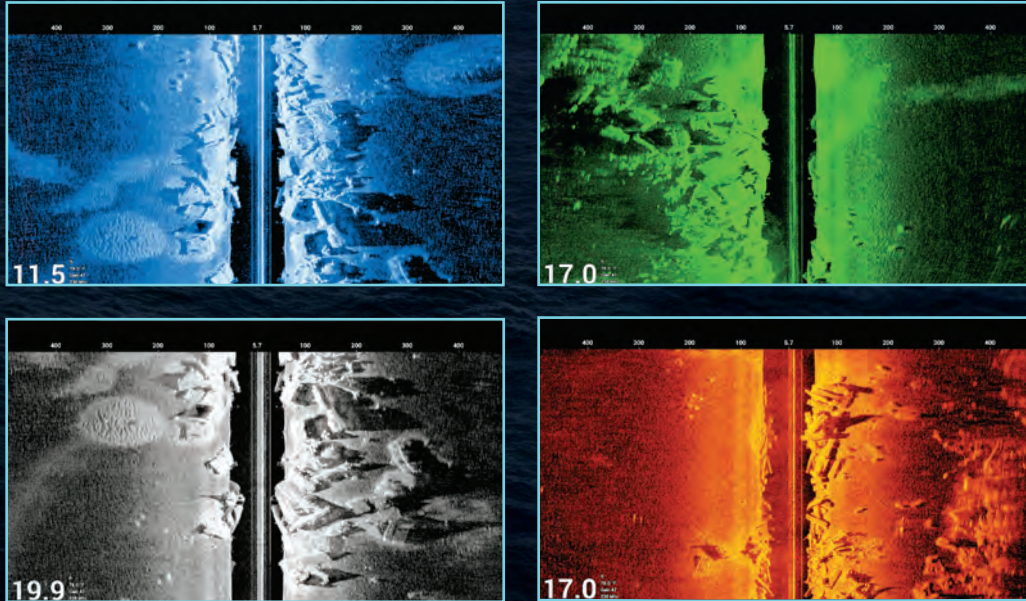

## DRIFT-IT, FISH-IT... CATCH IT

When a Fish-It point has been selected, the Drift-It feature can set the perfect drift. Drift-It will save you time and fuel by eliminating the guesswork in determining vessel drift in challenging wind and current conditions.

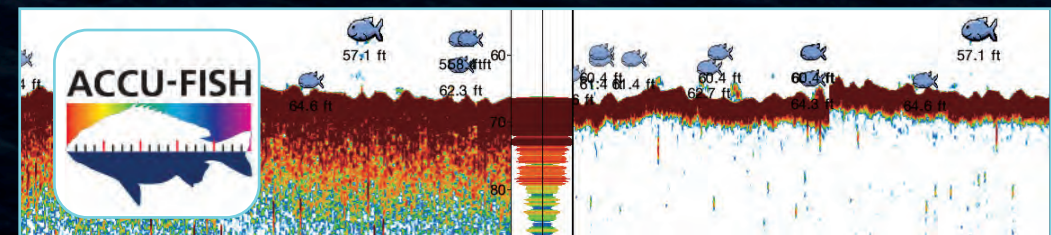
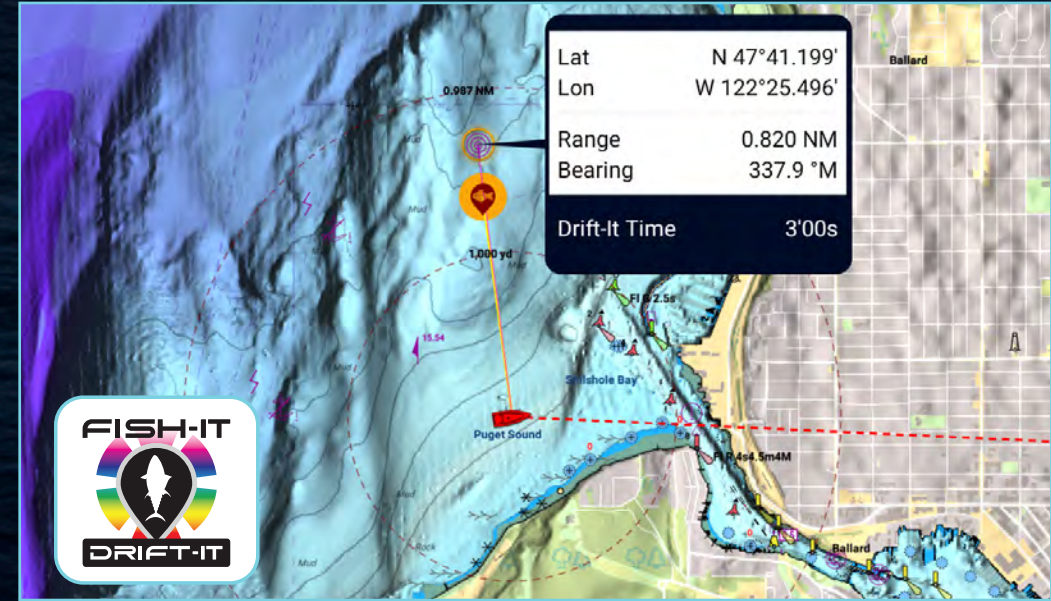

## BOTTOM DISCRIMINATION\* & ACCU-FISH™ FISH SIZE ANALYZER\*\*

Bottom Discrimination indicates if the seafloor is made up of sand, mud, gravel, or rocks. ACCU-FISH™ analyzes echo returns to compute individual fish size, ranging from 10 cm up to 199 cm (>4" to <78") long.

\* Feature works only with certain transducers. Check to ensure your transducer is compatible.

\*\* In some instances, fish size indicated on the TZtouchXL may differ from its actual size. Please carefully read the operator's manual before utilizing this feature.

# Discover A New World Beneath The Surface

Normal down-sounding Fish Finders have a beam angle of 40° or less. But with the DFF3D Multibeam Sonar, you'll see a 120-degree swath, offering coverage up to 3X water depth (example: 300' side-to-side in 100' water depth). Plus, with the power of the DFF3D, you can see fish directly below the boat 300m (nearly 1,000ft). When you match this with the DFF3-UHD TruEcho CHIRP™, you'll have the ultimate fishing machine!



DFF3D Multibeam Sonar

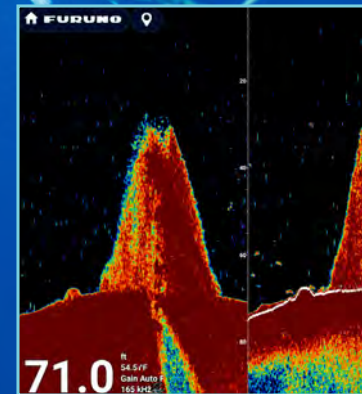
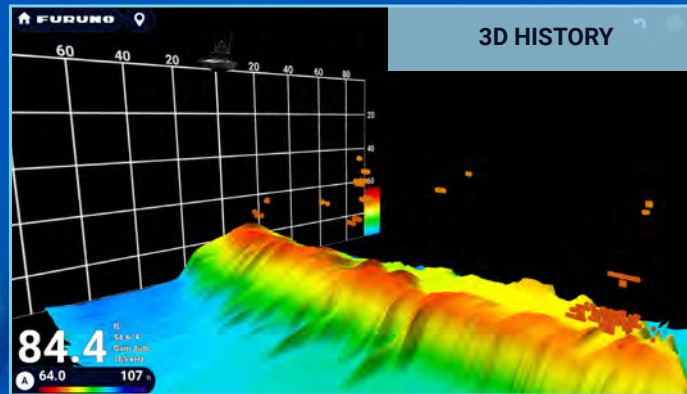
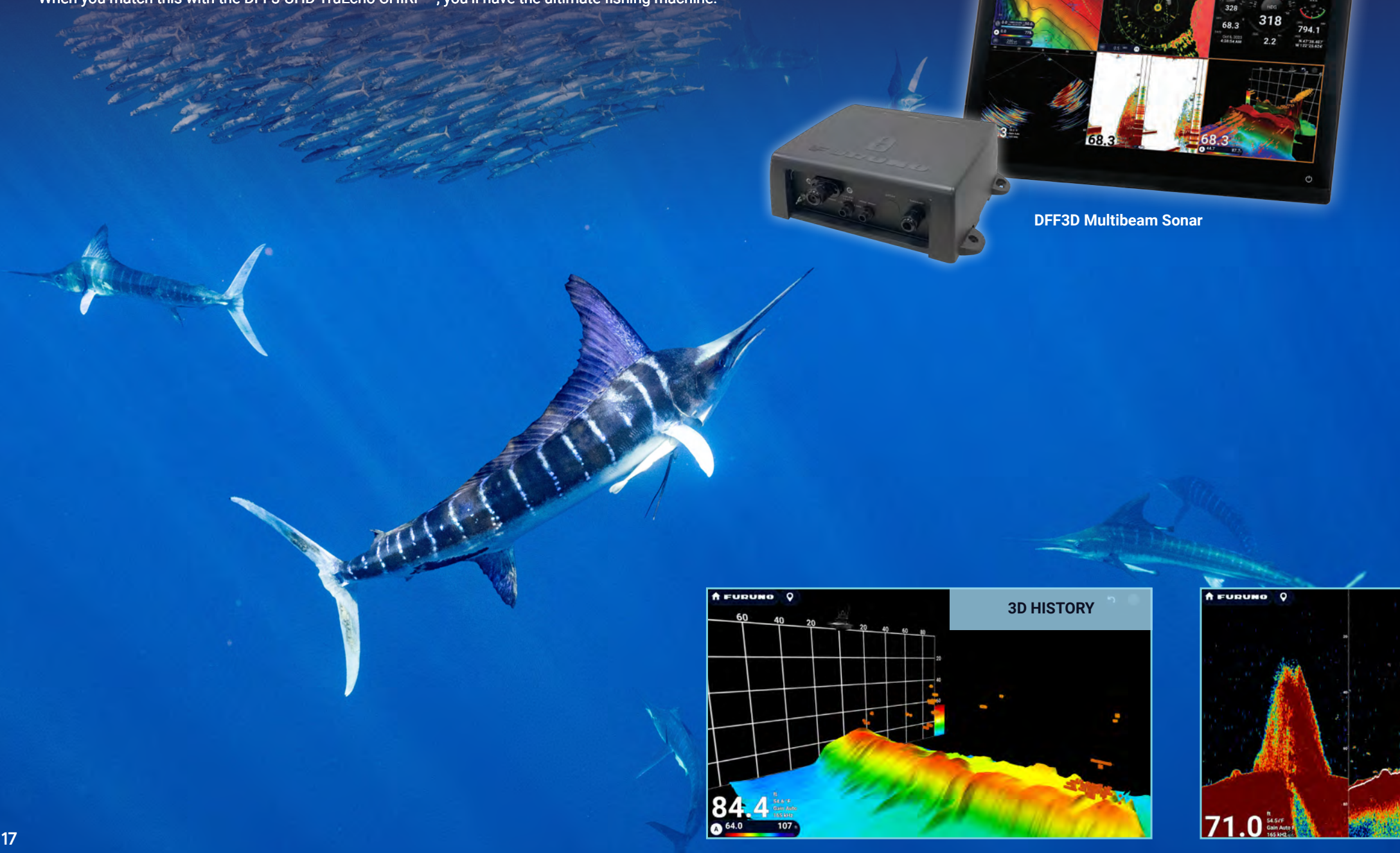

## BATHYMETRIC SHADED RELIEF MAPS

Quickly create your own PBG (Personal Bathymetric Generator) Shaded Relief Maps using TZtouchXL and the DFF3D. Bottom images are drawn with shaded relief, depth contours, and variable colors, making it easy to identify hidden structure and ridges that hold fish in a simple, easy-to-interpret presentation. Multiple color palettes are available, including the ability to show contour lines only.

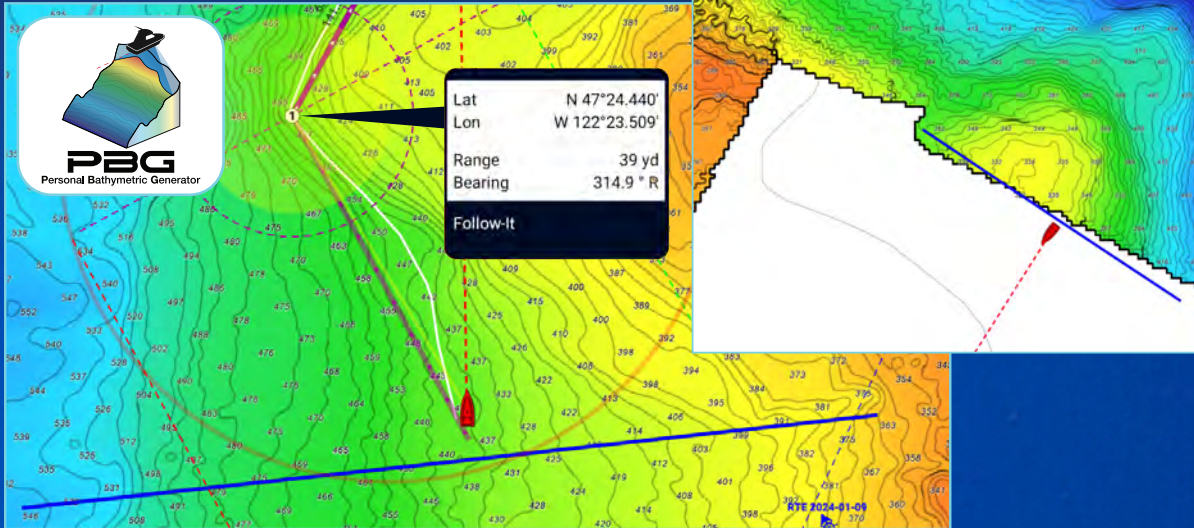

## FOLLOW-IT FEATURE

Leverage your recorded PBG data by creating a constant depth route from the PBG data, allowing you to select Follow-It from the menu and send it to your NAVpilot AutoPilot. This is particularly useful when you want to keep your bait at a certain depth while trolling without having to adjust your reel.

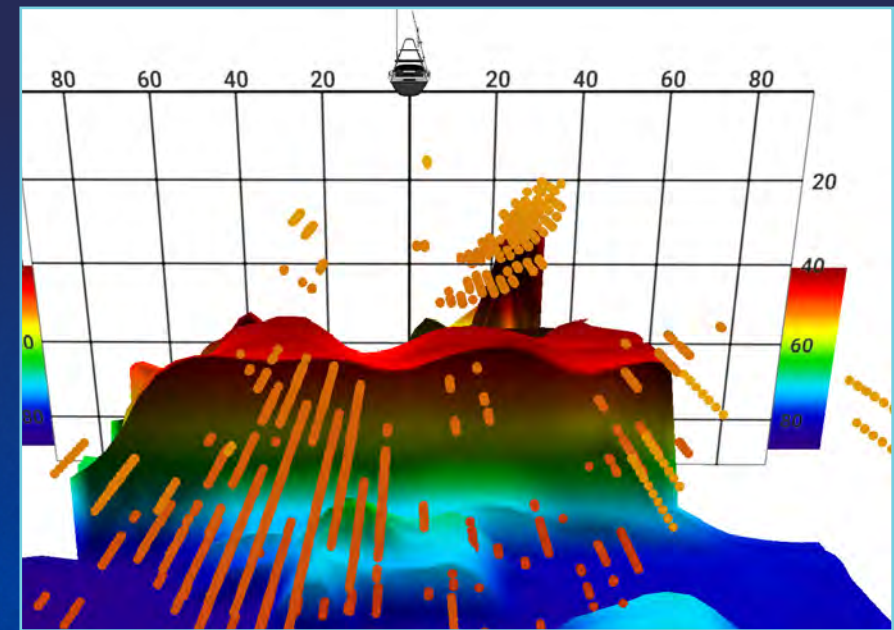
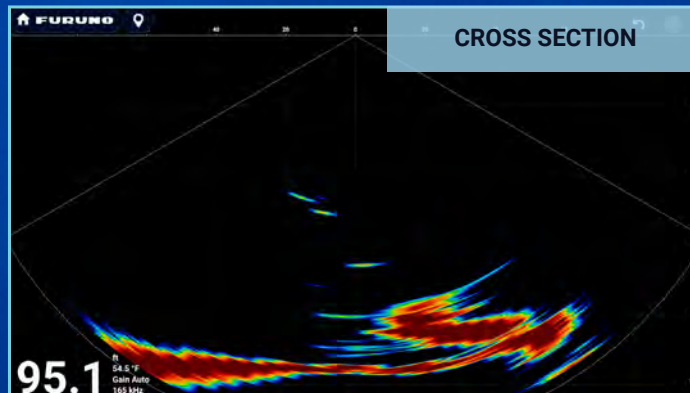
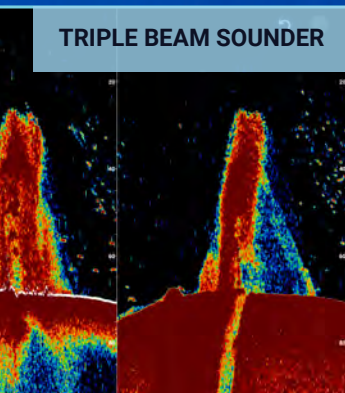

## MORE POWER TO SEE 120° PORT - STARBOARD

The DFF3D Multibeam Sonar operates at 165kHz, giving you fantastic depth penetration with high-resolution echoes. Compared to a 40° ultra-wide transducer, you will see 3-times the area around your boat, helping you to find fish you might have otherwise missed.

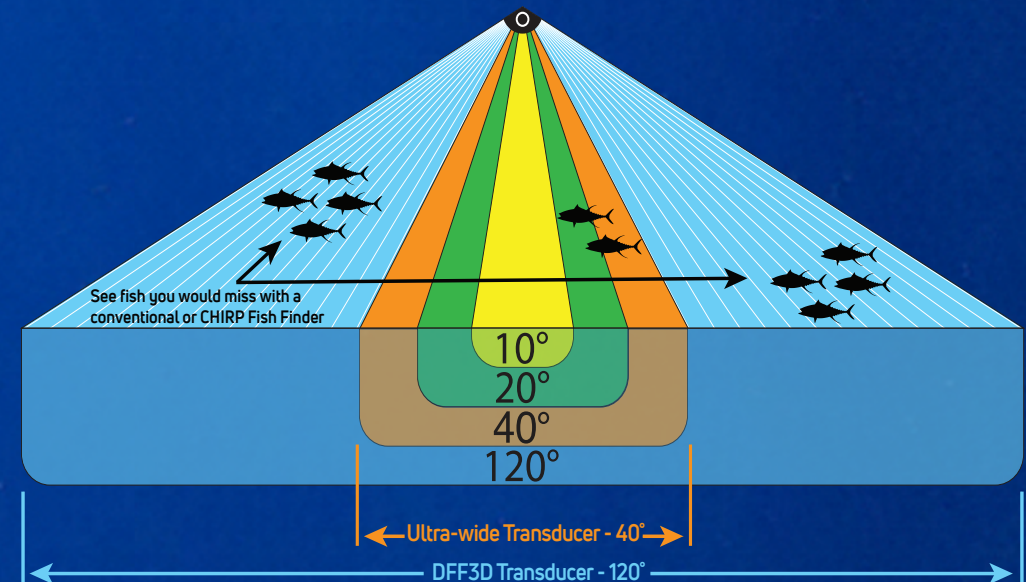



# Never Lose Waypoints, Routes, Or Settings With TZ Cloud

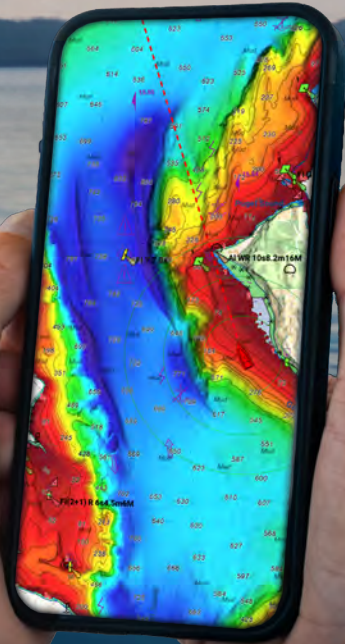
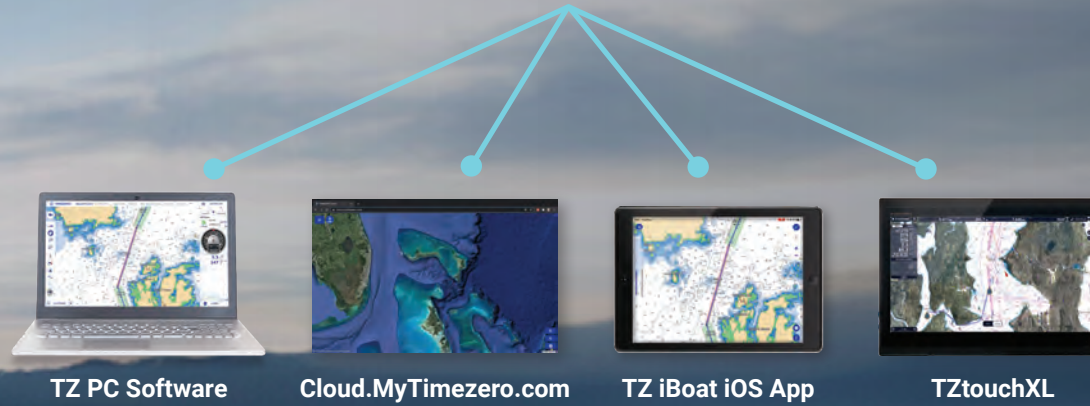

## NavNet VIEWER APP

View instruments on your handheld device

## NavNet REMOTE APP

View and operate your system on your handheld device

## NavNet CONTROLLER APP

Control your system with this simple app

## TZ FIRST MATE APP KEEPS TRACK OF YOUR CATCH & LOCATION

Drop an event mark. Upload a photo of your catch from your phone and record species, weight, length and more! View & edit the marks on your smart devices with the TZ First Mate App, TZ PC Software, or TZ iBoat



# RADAR



Radar Sensor  
 DRS4DL+ / DRS4D /  
 DRS2DNXT / DRS4DNXT  
 DRS6A / 12A / 25ANXT  
 DRS6AX / 12AX / 25AX X-Class  
 Ethernet

# NavNet TZtouchXL Network / Product Lineup



NavNet TZtouchXL is NMEA2000 certified. NMEA2000 offers improved data transfer rates and true plug-and-play operation.

# FISH FINDER



External Fish Finders can also be connected to TZtouchXL. You can select which one to use from the settings menu.



Fish Finder / TruEcho CHIRP™ 2/3kW<sup>1</sup>  
 DFF1-UHD / DFF3-UHD  
 Ethernet



Bottom Discrimination Fish Finder  
 BBDS1  
 Ethernet



Multibeam Sonar  
 DFF3D  
 Ethernet

# AIS



AIS Receiver  
 FA40  
 NMEA2000 NMEA0183



Class-B AIS Transponder  
 FA70  
 NMEA2000 NMEA0183



Class-A AIS Transponder  
 FA170  
 NMEA0183 Ethernet

# WEATHER/ PC PLOTTER



TZ PC Software  
 Ethernet



Network Weather Facsimile Receiver  
 FAX30  
 Ethernet



Network Satellite Weather and Radio Receiver  
 BBWX4\*<sup>2</sup>  
 Ethernet

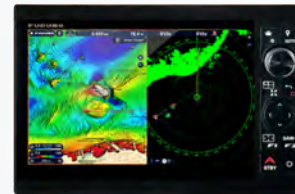

**TZT10X**  
 10" Hybrid Control

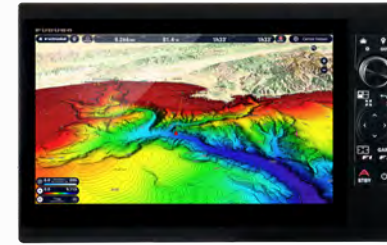

**TZT13X**  
 13" Hybrid Control



**TZT16X**  
 16" Multi Touch

# OTHERS

NavNet Command Center \*More apps planned  
 3rd Party Compatible Apps (v2.01\*)



Marine Entertainment System  
 Fusion APOLLO Series, etc.  
 Ethernet NMEA2000



IP Camera  
 Ethernet



Analog Camera  
 Video



Thermal Camera  
 Ethernet Video



Digital Switching System  
 CAN bus



Internal GPS Antenna  
 TZT10X/TZT13X/TZT16X

# CONVERTERS



NMEA Data Converter  
 IF-NMEA2K2  
 CAN bus NMEA0183



Analog NMEA Data Converter  
 IF-NMEAFI  
 CAN bus Analog



IP Video Stream Encoder (VGA)  
 VI-CSH8L  
 Video Ethernet



IP Video Stream Encoder (HDMI)  
 VI-HDMI  
 Video Ethernet



Internal 1kW TruEcho CHIRP™ Fish Finder\*  
 \*Dual Channel for TZT10X/TZT13X/TZT16X only

\*1 Optionally connect a 5kW or 10kW transducer to DFF3-UHD using BT-5  
 \*2 SiriusXM weather coverage is currently available only in U.S. and Canada. SiriusXM subscription required.

# NAVnet

**TZ**  
touchXL



AutoPilot  
NAVpilot 300  
NMEA2000



AutoPilot  
NAVpilot 711C  
NMEA2000 NMEA0183

## AUTOPILOT



Integrated Heading Sensor  
PG700  
CAN bus



Satellite Compass  
SCX20  
NMEA2000



Satellite Compass  
SC33  
NMEA2000



Satellite Compass  
SC70  
CAN bus NMEA0183

## COMPASS

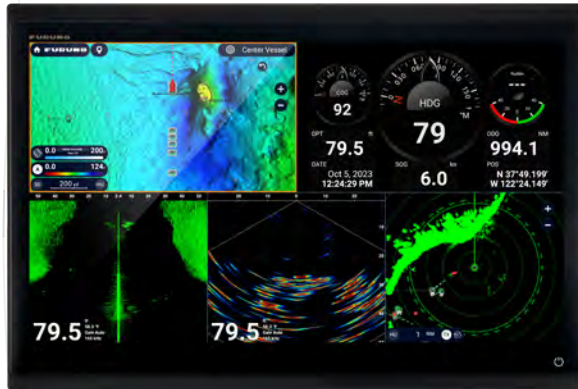

**TZT22X**  
22" Multi Touch

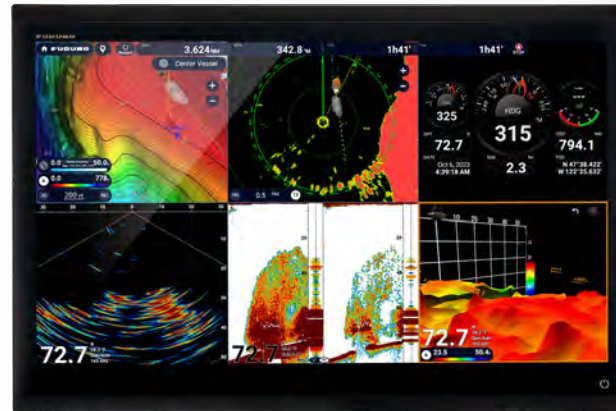

**TZT24X**  
24" Multi Touch



GPS/WAAS  
Receiver Antenna  
GP330B  
NMEA2000



External GPS antennas & navigators  
can also be connected to TZtouchXL.  
You can select which one to  
use from the settings menu.

## GPS



Ultrasonic Weather Station  
200WX  
CAN bus



Depth/Speed/Temp Sensor  
DST800 series & other Smart Sensors for depth/speed/temp  
CAN bus

## SENSOR

### Interface Connection Legend

- Ethernet 100 Base-T Connection
- Can bus or NMEA2000 Connection
- NMEA0183 Connection
- Video Connection
- Analog Connection
- USB Connection



Touch Encoder Unit  
TEU001B (Black)  
TEU001S (Silver)



Wind Transducer - Analog  
FI5001/L  
NMEA2000



Instrument  
FI70  
CAN bus

## INSTRUMENTS



Enhanced Remote Controller  
MCU006H  
USB



Enhanced Remote Controller  
MCU006  
USB



Remote Control Unit  
MCU004  
USB



Remote Control Unit  
MCU002  
USB



Keyboard  
MCU005  
Ethernet

## REMOTES

# Specifications - NavNet TZtouchXL

MODEL	TZT10X	TZT13X	TZT16X	TZT22X	TZT24X
<b>DISPLAY UNIT</b>					
Type	Color TFT multi touch IPS LCD				
Screen Size	10.1" Wide	13.3" Wide	15.6" Wide	21.5" Wide	24" Wide
Screen Resolution	WUXGA 1920 x 1200	FHD 1920 x 1080	FHD 1920 x 1080	FHD 1920 x 1080	FHD 1920 x 1080
Screen Brightness	900 cd/m2 (typical)				
Display Colors	16,770,000 colors (Chart Plotter), 64 colors (Radar/Fish Finder)				
Language	Bulgarian, Chinese, Danish, English (USA/UK), Finnish, French, German, Greek, Italian, Japanese, Norwegian, Portuguese, Russian, Spanish, Swedish, Turkish, Polish				
<b>GPS/WAAS</b>					
Receiver Type	GPS: 72 channels, SBAS: 1 channel (C/A mode, WAAS)			---	---
Receiving Frequency	L1 (1575.42 MHz)			---	---
Time to First Fix	100 s (cold start)			---	---
Accuracy	10 m (GPS), 7 m (MSAS), 3 m (WAAS)			---	---
Position Update Interval	100 ms or 10 Hz			---	---
<b>CHART PLOTTER</b>					
Cartography	TZ MAPS, MM3 Vector, and CMOR capable (U.S. only)				
Memory Capacity	30,000 user points, 100,000 points for ship's tracks, 200 planned routes (500 points per route)				
Alarms	Anchor Watch, XTE, Depth*, Speed, Sea Surface Temperature*, Trip Distance, Fuel Gauge* (*external data required)				
<b>RADAR</b>					
Display Modes	Head-up, North-up* *Heading input required.				
Echo Trails	Interval: 15 s, 30 s, 1 min, 3 mins, 6 mins, 15 mins, 30 mins and continuous (Heading input required)				
Target Tracking	100 ARPA Targets (Radar dependent) with fully automatic target acquisition (Heading input required)				
Radar Alarms	Guard Zone, CPA/TCPA, Video, Azimuth, Heading Line				
<b>FISH FINDER</b>					
Transmit Frequency*	CW: 50/200 kHz, CHIRP: 40 kHz to 240 kHz (Low, Medium, and High)			---	---
Transducer	300/600 W or 1 kW* *Matching box MB1100 required for some transducers.			---	---
Display Range	2 to 1,200 m; shift 0 to 1,200 m (1,200-2,400m / 4,000-8,000ft)				
Extension Mode	ACCU-FISH™, A-Scope, Auto (Fishing/Cruising), Bottom Discrimination, TruEcho CHIRP™ (with compatible transducer)				
Picture Advance	8 steps: x4, x2, x1, 1/2, 1/4, 1/8, 1/16, stop				
Fish Finder Alarms	Fish School, Fish School for bottom lock				
<b>SIDE-SCAN</b>					
Transmit Frequency*	CHIRP: 220-240KHz/445-465KHz			---	---
Transducer	230kHz: 225T-PR904, 225T-SS904. 225T-TM904 / 455kHz: 455T-PR903, 455T-SS903. 455T-TM903			Side-Scan with networked TZT10X, TZT13X, TZT16X Only	
Display Range	750 feet to each side				
Display Colors	Green, Blue, Amber, White				
Display Screen Sizes	Full Screen, 1/2 Screen, 1/4 Screen, 1/6 Screen Full Screen, 1/2 Screen, 1/4 Screen, 1/6 Screen				
Direct Connect to MFD	Direct connect to TZ10X, TZT13X, TZT16X only; may be networked with TZT22X/TZT24X				
<b>INTERFACE</b>					
NMEA2000	1 Port				
Input	065280, 126992/993/996, 127237/245/250/251/257/488/489/505, 128259/267, 129025/026/029/330/038/039/040/041/291/538/540, 129793/794/798/801/802/808/809/810, 130306/310/311/312/313/314/316/576/577/578, 130817/818/820/822/823/826/827/828/880				
Output	126992/993/996, 127250/251/257/258, 128259/267/275, 129025/026/029/033/283/284/285, 130306/310/311/312/313/314/316				
NMEA0183	1 Serial Output Port				
Output	AAM, APB, BOD, DBT, DPT, GGA, GLL, GNS, GSA, GSV, RMB, RMC, RTE, TTM, VDM, VTG, WPL, XTE, ZDA				
LAN	1 Port (1000 BASE-T)				
USB	1 Port (USB 3.0) for control unit		1 Port (USB 3.0) for touch monitor and control unit: 1 Port USB touch output for HDMI device		
Video I/O	Input: 1 port (NTSC/PAL)		Input: 1 port (NTSC/PAL) and 1 port HDMI 1920 x 1080p or less (progressive only) Output: 1 port (HDMI 1080p)		
AUX I/O	2 Ports (Event Switch, Buzzer Output, [10", 13" and 16" KP I/O], and External Power Switch)				
SD Card Slot	1 Slot (Micro SDXC, rear)				
Wireless LAN	IEEE802.11b/g/n, Transmit frequency: 2.412 to 2,462 GHz, 11dBm max				
Transducer Connection	1 Port 12 pin for CHIRP/CW, 1 Port 12 pin for Side-Scan			---	---
<b>ENVIRONMENT</b>					
Temperature (IEC60945)	-15°C to +55° C				
Relative Humidity	93% or less at +40° C				
Waterproofing	IP56				
<b>POWER</b>					
	12-24 VDC				
	T.B.D.	T.B.D.	T.B.D.	5.1-2.5A	6.7-3.2A



# Specifications - NavNet TZtouchXL Continued

## TZT10X

Multi Function Display (Tabletop Mount) TZT10X 3.9 kg 8.6 lb

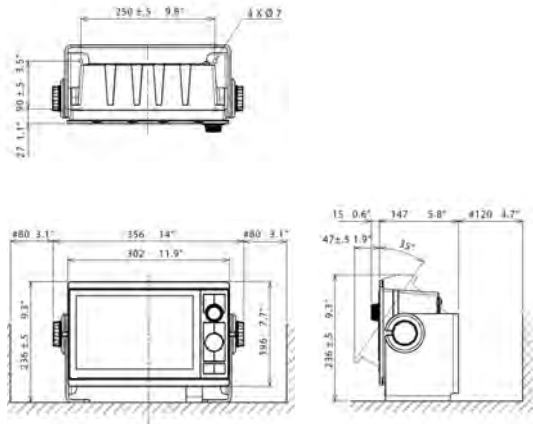

## TZT13X

Multi Function Display (Tabletop Mount) TZT13X 5.4 kg 11.9 lb

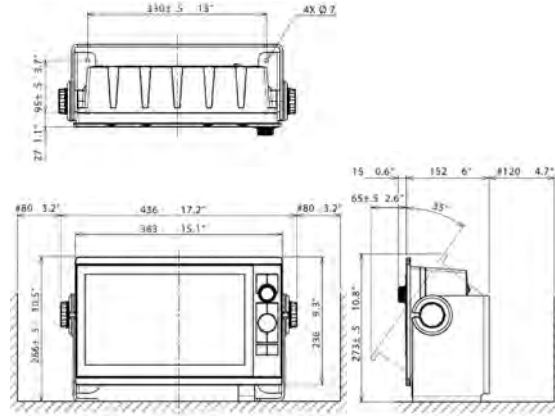

## TZT16X

Multi Function Display (Tabletop Mount) TZT16X 5.9 kg 13.0 lb

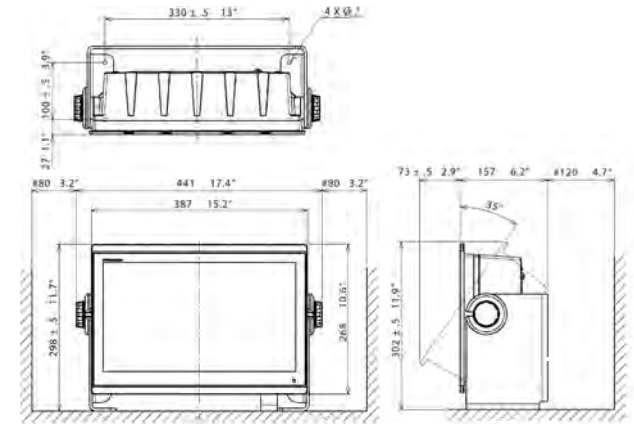

Multi Function Display (Flush Mount) TZT10X 2.9 kg 6.4 lb

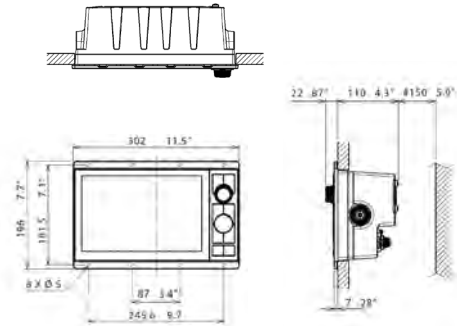

Multi Function Display (Flush Mount) TZT13X 4.1 kg 9.0 lb

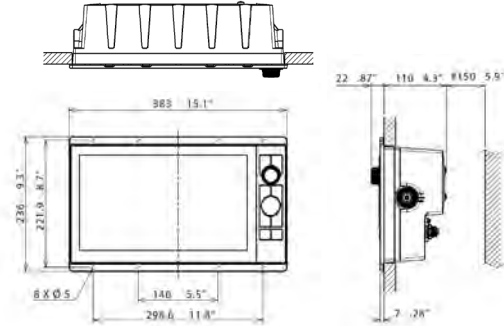

Multi Function Display (Flush Mount) TZT16X 4.4 kg 9.7 lb

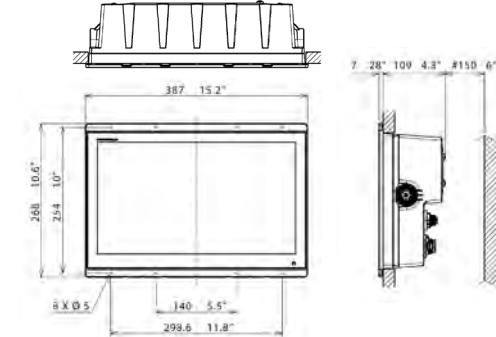

Multi Function Display Flush Mount TZT10X Cutout Dimension

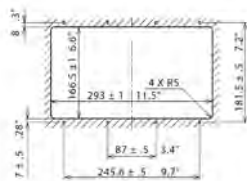

Multi Function Display Flush Mount TZT13X Cutout Dimension



Multi Function Display Flush Mount TZT16X Cutout Dimension

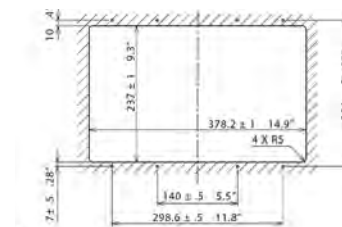

# Specifications - NavNet TZtouchXL Continued / Remote Controllers

## TZT22X

Multi Function Display (Tabletop Mount) TZT22X 5.7 kg 12.6 lb

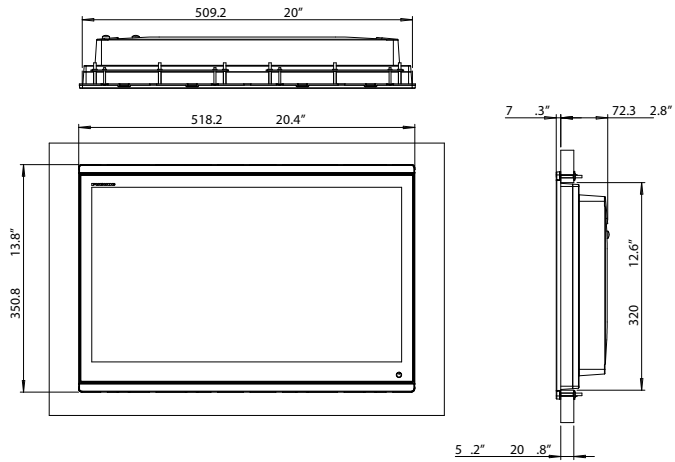

### Multi Function Display Flush Mount TZT22X Cutout Dimension

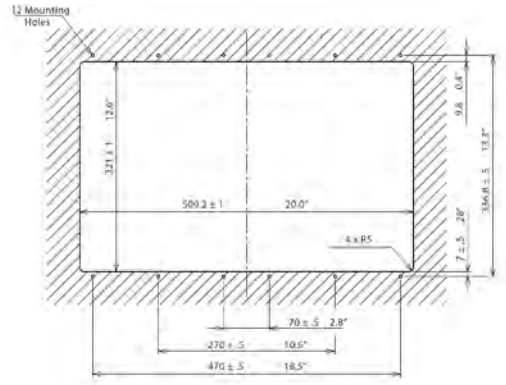

### Touch Encoder Unit TEU001B/S (option, U.S. and Canada only) 0.12 kg 0.26 lb

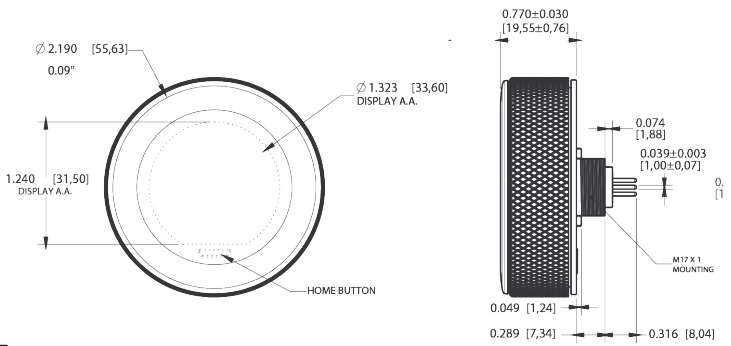

## TZT24X

Multi Function Display (Flush Mount) TZT24X 8.1 kg 17.9 lb

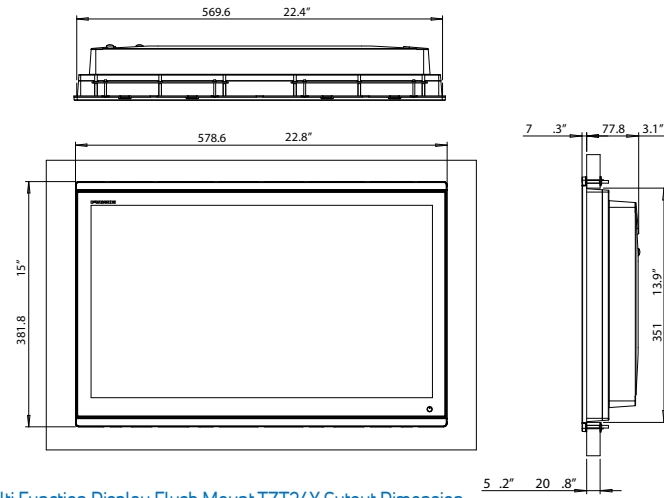

### Multi Function Display Flush Mount TZT24X Cutout Dimension



MATING CONNECTORS (OR EQUIVALENT):  
PHOENIX CONTACT P/N 1411976  
PHOENIX CONTACT P/N 1411977

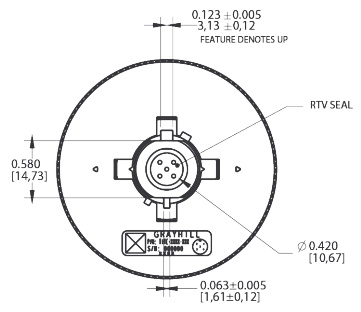

### Control Unit MCU006 (option) 0.2 kg 0.44 lb

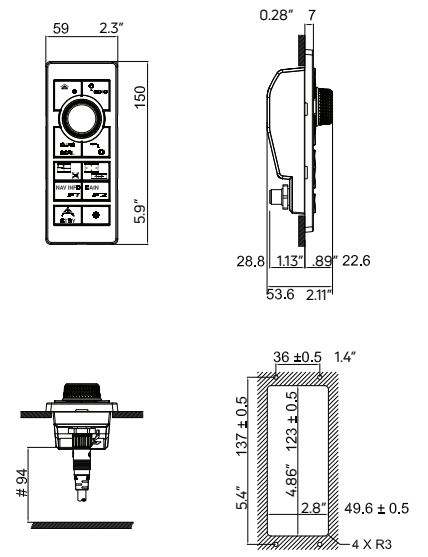

### Control Unit MCU006H (option) 0.2 kg 0.44 lb

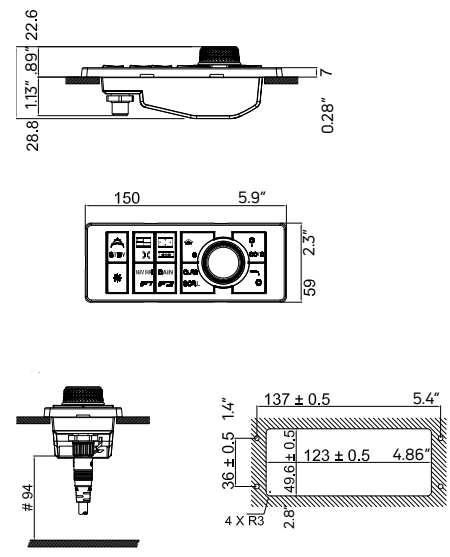

# Specifications - NavNet NXT Series Radar

MODEL		DRS2DNXT	DRS4DNXT	DRS6ANXT	DRS12ANXT	DRS25ANXT
<b>ANTENNA</b>						
Type		ø488 mm Radome (19")	ø610 mm Radome (24")	ø1036 mm Open (3.5') 1255 mm Open (4') 1795 mm Open (6')	ø1036 mm Open (3.5') 1255 mm Open (4') 1795 mm Open (6')	ø1036 mm Open (3.5') 1255 mm Open (4') 1795 mm Open (6')
Beam Width	Horizontal	5.2° typical (-3 dB) Adjustable between 2.6° and 5.2° (Array basic beamwidth shown; RezBoost also available)	3.9° typical (-3 dB) Adjustable between 2° and 3.9° (Array basic beamwidth shown; RezBoost also available)	2.3°/1.9°/1.35° (Array basic beamwidth shown; RezBoost also available)	2.3°/1.9°/1.35° (Array basic beamwidth shown; RezBoost also available)	2.3°/1.9°/1.35° (Array basic beamwidth shown; RezBoost also available)
	Vertical	25°		22°/22°/22°	22°/22°/22°	22°/22°/22°
Antenna Rotation Speed	24*/36/48 rpm range coupled or 24 rpm fixed * In dual range mode, speed is limited to 24 rpm					
<b>RF TRANSCEIVER</b>						
Frequency	CH1: 9380 MHz (P0N), 9400 MHz (Q0N) CH2: 9400 MHz (P0N), 9420 MHz (Q0N) CH3: 9420 MHz (P0N), 9440 MHz (Q0N)					
Pulselength & PRR	P0N: 0.08 µs to 1.2 µs/1100 Hz Q0N: 5 µs to 18 µs/1100 Hz			P0N: 0.04µs to 1.2µs/ 700Hz to 2000Hz Q0N: 5µs to 48µs/ 700Hz to 2000Hz		
Peak Output Power	Solid-State, 25 W				Solid-State, 100 W	Solid-State, 200 W
Range Scales	0.0625 to 48* NM * In dual range mode, range is limited to 12 NM			0.0625 to 72* NM * In dual range mode, range is limited to 12 NM		0.0625 to 96* NM * In dual range mode, range is limited to 12 NM
Bearing Accuracy	±1°					
<b>INTERFACE</b>						
Ports	LAN: 1 port, Ethernet, 100Base-TX RJ45					
<b>ENVIRONMENT</b>						
	Temperature: -25°C to +55°C, Waterproofing: IP56			Temperature: -25°C to +55°C, Waterproofing: IP56		
<b>POWER SUPPLY</b>						
	12-24 VDC, 2.5-1.3 A			12/24 VDC, 9.5/5.0 A		24 VDC, 5.0 A
						24 VDC, 5.6 A

19" Radome Radar Sensor DRS2DNXT 6.5 kg 14.3 lb

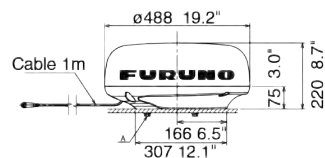

24" Radome Radar Sensor DRS4DNXT 7.3kg 16.1 lb

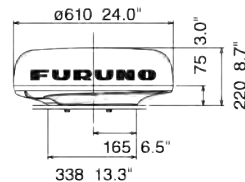

3.5 ft Open Array NXT Radar 22kg 48.5 lb  
4 ft Open Array NXT Radar 25kg 55.1 lb  
6 ft Open Array NXT Radar 27kg 59.5 lb

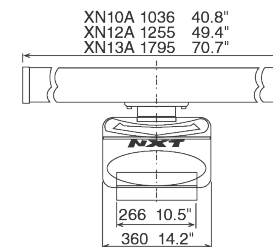

# Specifications - NavNet X-Class Series Radar

MODEL	DRS4DL+	DRS6AX X-Class	DRS12AX X-Class	DRS25AX X-Class
<b>ANTENNA</b>				
Type	ø480 mm Radome (19")	ø1036 mm Open (3.5') 1255 mm Open (4') 1795 mm Open (6')	ø1255 mm Open (4') 1795 mm Open (6')	
Beam Width	Horizontal	5.2°	2.3°/1.9°/1.35°	1.9°/1.35°
	Vertical	25°	22°/22°/22°	
Antenna Rotation Speed	24 rpm	24/36/48 rpm range coupled or 24 rpm fixed		
<b>RF TRANSCEIVER</b>				
Frequency	9410 ± 30 MHz	9410 ±30 MHz		
Pulse length & PRR	S: 0.08 µs/360 Hz (0.0625 to 0.5 NM) M: 0.3 µs/360 Hz (0.75 to 2 NM) L: 0.8 µs/360 Hz (3 to 36 NM)	0.08 µs/3000 Hz (0.0625 to 0.75 NM) 0.15 µs/3000 Hz (1 to 1.5 NM) 0.3 µs/1500 Hz (2 NM) 0.5 µs/1000 Hz (3 to 4 NM) 0.8 µs/600 Hz (6 to 9 NM) 1.2 µs/600 Hz (12 to 64 NM) 1.2 µs/550 Hz (72 to 96 NM)		
Peak Output Power	4 kW	6kW	12kW	25kW
Range Scales	0.0625 to 36* NM	0.0625 to 96 NM		
Bearing Accuracy	±1°			
<b>INTERFACE</b>				
Ports	----	LAN: 1 port, Ethernet, 100Base-TX RJ45		
<b>ENVIRONMENT</b>				
	Temperature: -25°C to +55°C, Waterproofing: IPX6	Temperature: -25°C to +55°C, Waterproofing: IP56		
<b>POWER SUPPLY</b>				
	12-24 VDC, 2.1-1.0 A	24 VDC, 4.0 A	24 VDC, 4.5 A	24 VDC, 5.6 A

19" Radome Radar Sensor DRS4DL+ 5.7kg 12.6 lb

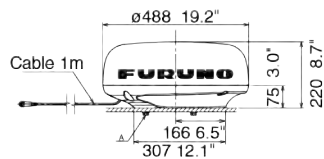

3.5 ft Open Radar Sensor X-Class 20.0 kg 44.1 lb  
4 ft Open Radar Sensor X-Class 21.0 kg 46.3 lb  
6 ft Open Radar Sensor X-Class 23.0 kg 50.7 lb

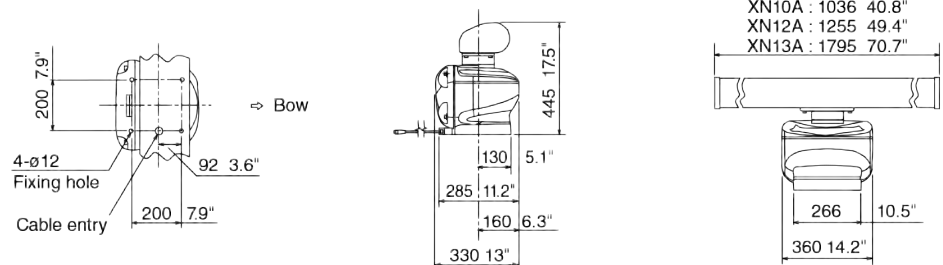

# Specifications - NavNet Series Fish Finders

MODEL	DFF1-UHD	BBDS1	DFF3-UHD
<b>TRANSCIVER &amp; DISPLAY</b>			
Display Modes	Single (High or Low frequency), Dual (Both High and Low frequencies), Bottom-lock, Bottom-Zoom, ACCU-FISH™, Bottom Discrimination, Marker Zoom, A-Scope	Single (50 or 200 kHz), Dual (50 and 200 kHz), Bottom-lock, Bottom-Zoom, ACCU-FISH™, Bottom Discrimination, Marker Zoom, A-scope	Single (High or Low frequency), Dual (Both High and Low frequencies), Bottom-lock, Bottom-Zoom, A-Scope
Frequency	Dual frequency 30-70 & 175-225 kHz	Dual frequency 50 and 200kHz	The synthesized transducer works with dual frequencies between 28 and 200 kHz (Low, Medium, and High CHIRP ranges)
Broadband (CHIRP)	Available	N/A	Yes
Range Scale	Max. 1,000m	Max. 1,200m	Max. 3,000m; shift 0-2,000m (2,000-5,000m / 6,000-15,000ft)
Output Power	1kW	1kW	2kW/3kW/5kW/10kW*
<b>ENVIRONMENT</b>			
Temperature	N/A	-15°C to +55°C	
Waterproofing	IP55	IP20	IP20
<b>POWER SUPPLY</b>			
	12-24 VDC		12-24 VDC
	30 W, 2.8-1.4 A	12 W, 1.1-0.4 A	3.0-1.6 A (stand-by: 0.8-0.4 A)
<b>TRANSDUCERS (Specify when ordering)</b>			
	<b>1 kW</b> Broadband transducers by AIRMAR 42-65 kHz (low), 130-210 kHz (high) CM265LH, B265LH (with temperature sensor) CM275LHW, B275LHW	<b>600 W</b> 50/200 kHz: 520-5PSD (Plastic, thru-hull), 520-5MSD (Bronze, thru-hull), 525-5PWD (Plastic, transom), 525STID-MSD (Bronze, thru-hull with speed/temp sensor), 525STID-PWD (Plastic, transom with speed/temp sensor) <b>1 kW</b> (Optional Matching Box, MB1100 may be required) 50/200 kHz: 50/200-1T, 50/200-12M	<b>CHIRP 2/3 kW</b> 2kW/1kW: PM111LHW, R109LHW 2kW/2kW: PM111LH, PM411LWM, R109LH, R109LM, R111LH, R111LM, R409LWM, 165T-PM542LM 3kW/1kW: R509LHW 3kW/2kW: CM599LH, CM599LM, R509LM, R599LH, R599LM  <b>CW 2/3/5/10 kW</b> 28 kHz: CA28BL-6HR, CA28BL-12HR, CA28F-38M, CA28F-72 38kHz: CA38BL-9HR, CA38BL-15HR 50kHz: CA500BL-12HR, CA50BL-24HR, CA50F-38, CA50F-70 68 kHz: CA68F-30H, CA82B-35R 82kHz: CA82B-35R 88 kHz: CA82B-35R, CA100B-10R 150 kHz: CA150B-12H 200 kHz: CA200B-8/8B, CA200B-12H  *BT-5 Required for 5kW/10kW Transducers

Network Fish Finder DFF1-UHD

3.1 kg 6.8 lb

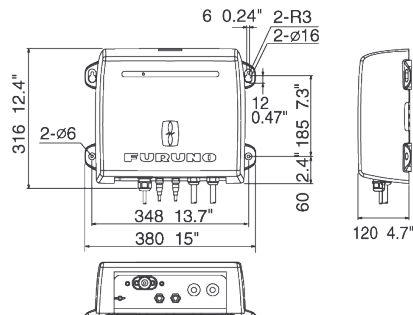

Network Fish Finder/Bottom Discrimination Sounder BBDS1 1.3 kg 2.9 lb

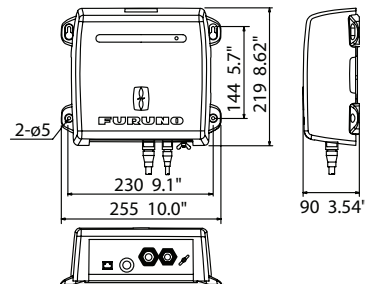

Network Fish Finder DFF3-UHD

3.8 kg 8.4 lb

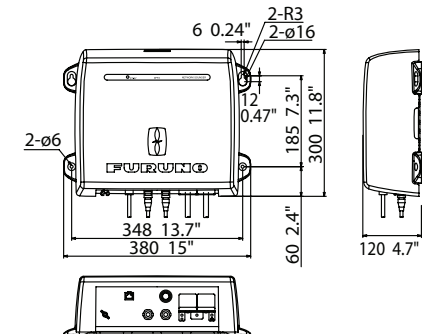

# Specifications - NavNet Series Multibeam Sonar | AIS Receiver & Transponder

MODEL	DFF3D NETWORK MULTIBEAM SONAR
<b>TRANSCEIVER &amp; DISPLAY</b>	
Display Mode	Cross Section, Triple/Single Beam Sounder, Side-Scan, 3D Sounder History, PBG (Personal Bathymetric Generator)
Frequency	165 kHz
Beam Angle	60° Port/Stbd, 120° total
Detection Range	200 m* (Side beam best performance) 300 m* (Main beam directly under boat) * Depending on bottom type and water conditions.
Range Scale	5-1,200m
<b>INTERFACE</b>	
LAN	1 port, Ethernet 10/100Base-TX
External KP	1 port (optional external KP kit required)
<b>ENVIRONMENT</b>	
Temperature	-15°C to +55°C
Waterproofing	IP55
<b>POWER SUPPLY</b>	
	12-24 VDC, 1.4-0.7 A
<b>TRANSDUCER</b>	
	165T-B54 or 165T-SS54 (thru-hull mount), or 165T-TM54 (transom mount) Combo Transducers: 165T-50/200-SS260 (thru-hull mount), 165T-265LH-PM488 (pocket mount), or 165T-50/200-TM260 (transom mount)

Network Multibeam Sonar DFF3D

3.0 kg 6.6 lb

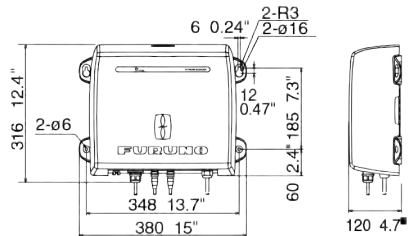

FA40/70 AIS Receiver

1.5 kg 3.3 lb

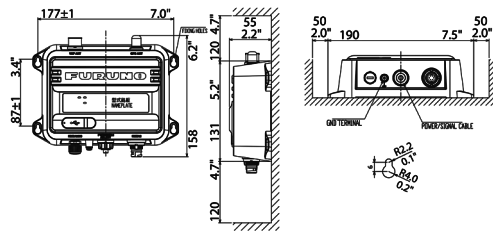

MODEL	FA40 AIS RECEIVER	FA70 CLASS - B+ AIS TRANSPONDER
<b>STANDARDS</b>		
	IEC 60945 Ed.4 IMO MSC.140 (76) ITU-R M.1371-5, EN 303 413 V1.1.1 EN 301 843-1 V2.2.1 IEC 60945 Ed.4+CORR.1, IEC 62368-1 Ed.3	IMO MSC.140 (76) ITU-R M.1371-5, DSC: ITU-R M.825-3 IEC 62287-1 Ed.3.0, IEC 62287-2 Ed.2.0, EN 303 413 V1.1.1 EN 301 843-1 V2.2.1 IEC 60945 Ed.4+CORR.1, IEC 62368-1 Ed.3, IEC 62311 Ed.1+Ed.2
<b>TRANSPONDER UNIT* *FA40: RECEIVER UNIT</b>		
TX/RX Frequency (FA40: RX Frequency)	156.025 to 162.025 MHz	
Output Power	---	5W or 1W(SOTDMA), 2W(CSTDMA)
Channel Spacing	25 kHz	25 kHz
<b>GPS RECEIVER</b>		
Receiving Channels	---	12 channels, SBAS 2 channels, 14 satellites tracking
Rx Frequency	---	1575.42 MHz
Rx Code	---	C/A code
Position Accuracy	---	13 m ( 2 drms, HDOP <= 4)
<b>INTERFACE</b>		
NMEA0183	Input	ACA, ACK, AIQ, DTM, GBS, GGA, GLL, GNS, HDT, OSD, RMC, SSD, THS, VBW, VSD, VTG
	Output	ABK, ACA, ACS, ALR, GGA, GLL, RMC, SSD, TXT, VDM, VDO, VER, VSD, VTG
NMEA2000	Input	059392, 059904, 060160, 060416, 060928, 065240, 126208, 127250
	Output	059392, 059904, 060928, 126208, 126464, 126992, 126993, 126996, 126998, 127258, 129025, 129026, 129029, 129038, 129039, 129040, 129041, 129540, 129792, 129793, 129794, 129795, 129796, 129797, 129798, 129800, 129801, 129802, 129803, 129804, 129805, 129806, 129807, 129809, 129810, 129811, 129812, 129813
<b>ENVIRONMENT</b>		
Temperature	Antenna Unit	-25°C to +70°C
	Other Units	-15°C to +55°C
Waterproofing	Antenna Unit	IP56
	Other Units	IP55
<b>POWER SUPPLY</b>		
Transponder Unit (FA40: Receiver Unit)	12-24 VDC, 0.3-0.2 A	12-24 VDC, 1.8-0.9 A
Display Unit:	---	---

Take a deep dive into TZtouchXL  
with videos and in-depth information  
on the entire series at [NavNet.com](http://NavNet.com)





[www.furuno.com](http://www.furuno.com)  
[www.navnet.com](http://www.navnet.com)

**BEWARE OF SIMILAR PRODUCTS**

All brand and product names are trademarks, or service marks of their respective holders.

**FURUNO ELECTRIC CO., LTD.**  
Japan [www.furuno.com](http://www.furuno.com)

**FURUNO U.S.A., INC.**  
U.S.A. [www.furunousa.com](http://www.furunousa.com)

**FURUNO PANAMA S.A.**  
Republic of Panama [www.furuno.com.pa](http://www.furuno.com.pa)

**FURUNO (UK) LIMITED**  
U.K. [www.furuno.co.uk](http://www.furuno.co.uk)

**FURUNO NORGE A/S**  
Norway [www.furuno.no](http://www.furuno.no)

**FURUNO DANMARK A/S**  
Denmark [www.furuno.dk](http://www.furuno.dk)

**FURUNO SVERIGE AB**  
Sweden [www.furuno.se](http://www.furuno.se)

**FURUNO FINLAND OY**  
Finland [www.furuno.fi](http://www.furuno.fi)

**FURUNO POLSKA Sp. z o.o.**  
Poland [www.furuno.pl](http://www.furuno.pl)

**FURUNO DEUTSCHLAND GmbH**  
Germany [www.furuno.de](http://www.furuno.de)

**FURUNO FRANCE S.A.S.**  
France [www.furuno.fr](http://www.furuno.fr)

**FURUNO ESPAÑA S.A.**  
Spain [www.furuno.es](http://www.furuno.es)

**FURUNO ITALIA S.R.L.**  
Italy [www.furuno.it](http://www.furuno.it)

**FURUNO HELLAS S.A.**  
Greece [www.furuno.gr](http://www.furuno.gr)

**FURUNO (CYPRUS) LTD**  
Cyprus [www.furuno.com.cy](http://www.furuno.com.cy)

**FURUNO SHANGHAI CO., LTD.**  
China [www.furuno.com/cn](http://www.furuno.com/cn)

**FURUNO CHINA CO., LTD.**  
Hong Kong [www.furuno.com/cn](http://www.furuno.com/cn)

**FURUNO KOREA CO., LTD**  
Korea

**FURUNO SINGAPORE**  
Singapore [www.furuno.sg](http://www.furuno.sg)

**PT FURUNO ELECTRIC INDONESIA**  
Indonesia [www.furuno.id](http://www.furuno.id)

**FURUNO ELECTRIC (MALAYSIA) SDN. BHD.**  
Malaysia [www.furuno.com/my](http://www.furuno.com/my)

SPECIFICATIONS SUBJECT TO CHANGE WITHOUT NOTICE

Catalog No. LIT-TZT-XLX  
Ver. B  
Printed in USA